

LUCE,
COME E
DOVE
VUOI.

2023 LAMPADE RICARICABILI RECHARGEABLE LAMPS

Perennia®

I L L U M I N A

dal 1962

LAMPADRE RICARICABILI
LUCE, COME E DOVE VUOI.

Liberi dalle prese, dai cavi, da posizioni statiche, fisse e predefinite. **Se tutto scorre anche la luce deve poter viaggiare nello spazio.** La selezione di lampade ricaricabili proposte da Perenz sono **un vero e proprio concept di luce:** un naturale gesto di accensione e **tutto si illumina, in un secondo, lontano dalla corrente, all'interno o all'esterno.**

La luce adesso si muove ed è immediatamente disponibile **laddove c'è desiderio di illuminare** una stanza, una veranda, un giardino, qualsiasi angolo del mondo. E inoltre: **arreda in modo dinamico creando ad ogni accensione un nuovo ambiente e una nuova emozione.**

Grazie alla loro **portabilità** e inimitabile **leggerezza questi oggetti di design** creano nuove atmosfere in pochi secondi e **fanno da cornice a momenti di vita, rendendoli indimenticabili. Diverse forme, colori e texture** per diverse qualità di luce. Ogni proposta ha la sua **personalità inconfondibile capace di adattarsi a diversi stili:** classico, moderno, contemporaneo, minimalista.

I **dispositivi touch**, la possibilità di **variare l'intensità luminosa**, l'opzione di **diverse temperature di luce** rendono ogni proposta magica e irresistibile. Una volta accesa, impossibile separarsi da una lampada ricaricabile che può essere portata ovunque anche in viaggio o in vacanza.

Scegli dalla nostra vasta gamma.
Finalmente la luce è come e dove vuoi.

RECHARGEABLE LAMPS
**LIGHT, HOW YOU WANT IT
AND WHERE YOU WANT IT.**

Free from sockets, cables, static, fixed, and predefined positions. **If everything flows, light must also be able to travel through space.** The selection of rechargeable lamps offered by Perenz are a **true lighting concept:** a natural switch-on gesture and **everything lights up, in a second, away from the power source, indoors or outdoors.**

Light now moves and is immediately available **wherever there is a desire to illuminate** a room, a veranda, a garden, any corner of the world. And what's more: **it furnishes dynamically creating a new environment and a new emotion every time it is switched on.**

Thanks to their **portability** and inimitable **lightness, these design objects** create new atmospheres in just a few seconds and **frame life's moments, making them unforgettable. Different shapes, colors, and textures** for different qualities of light. Each proposal has its own **unmistakable personality capable of adapting to different styles:** classic, modern, contemporary, minimalist.

The **touch devices**, the possibility of **varying light intensity**, and the option of **different light temperatures** make each proposal magical and irresistible. Once switched on, it is impossible to part with a rechargeable lamp that can be taken anywhere, even when travelling or on holiday.

Choose from our wide range.
Finally, light is how you want it and where you want it.

SWAY MOOD

REGISTERED DESIGN

**ORIENTABILE ED ESTETICA,
REINVENTA LE ATMOSFERE.
ARREDA LO SPAZIO SFUMANDO I
CONTORNI E RIDISEGNANDO GLI
AMBIENTI. IL MODULO VIAGGIA
ORIZZONTALE, VERTICALE, OBLIQUO
PER REGALARE UN'ATMOSFERA
INEDITA A SECONDA DELLA DIVERSA
INCLINAZIONE. AD OGNI GRADO
UN'EMOZIONE DIVERSA.**

**ORIENTABLE AND AESTHETIC,
IT REINVENTS ATMOSPHERES.
IT DECORATES SPACE BY BLURRING
CONTOURS AND REDESIGNING
ROOMS. THE MODULE TRAVELS
HORIZONTALLY, VERTICALLY,
OBLIQUELY TO PROVIDE A NEW
ATMOSPHERE DEPENDING ON
THE DIFFERENT ANGLES. AT EACH
DEGREE A DIFFERENT EMOTION.**





Articoli in foto Photo articles
8138 GS CT + 8140 B CT

Informazioni tecniche Technical information p.18-19



Articoli in foto Photo articles
modulo module: 8140 B CT + 8138 B CT
accessorio accessory: 8141 B

Informazioni tecniche Technical information p.18-19



Articoli in foto Photo articles
8136 B CT + 8134 E CT

Informazioni tecniche Technical information p.18-19



Articoli in foto Photo articles
8134 E CT + 8134 GS CT

**SWAY MOOD / PIANTANA**

... ANCORATO AD UNA BASE ARREDA IN MODO ORIGINALE E CONTEMPORANEO. LA SUA BASE SOLIDA TRASFORMA COMPLETAMENTE IL PROFILO DEL MODULO. COSÌ LO SPAZIO PRENDE VITA.

SWAY MOOD / FLOOR LAMP

... ATTACHING IT TO A BASE, IT FURNISHES IN AN ORIGINAL AND CONTEMPORARY STYLE. ITS SOLID BASE COMPLETELY TRANSFORMS THE PROFILE OF THE MODULE. THUS, THE SPACES COME TO LIFE.

Articoli in foto Photo articles
 modulo module: 8140 B CT
 accessorio accessory: 8141 B

Informazioni tecniche Technical information p.18-19



Articoli in foto Photo articles
 modulo module: 8140 GS CT
 accessorio accessory: 8141 GS

Informazioni tecniche Technical information p.18-19

**SWAY MOOD / APPLIQUE**

... AGGANCIATO AD UNA PARETE SI TRASFORMA IN UN ESSENZIALE SEGMENTO LUMINOSO. DA UN PUNTO PRECISO SI IRRADIA UNA NUOVA LUCE CAPACE DI MODIFICARE COMPLETAMENTE UN AMBIENTE.

SWAY MOOD / WALL LAMP

... PLACING IT ON A WALL, IT TRANSFORMS INTO AN ESSENTIAL LIGHT SEGMENT. FROM A PRECISE POINT, A NEW LIGHT RADIATES THAT CAN COMPLETELY CHANGE AN ENVIRONMENT.

Articoli in foto Photo articles
 modulo module: 8138 GS CT
 modulo module: 8136 GS CT
 accessorio accessory: 8144 GS

Informazioni tecniche Technical information p.18-19



Articoli in foto Photo articles
 modulo module: 8136 B CT
 accessorio accessory: 8144 B

Informazioni tecniche Technical information p.18-19



Per la sospensione orizzontale,
come da foto, servono 2 kit.
For the horizontal suspension,
as photo, 2 kits are needed.



Articoli in foto Photo articles
modulo module: 8138 GS CT
accessorio accessory: 8143 GS (2 pz.)

Informazioni tecniche Technical information p.18-19

SWAY MOOD / SOSPENSIONE

... **SOSPESO** PORTA LA LUCE ALL'ALTEZZA DEI TUOI DESIDERI. LA GRAVITÀ RIVOLUZIONA LA FORMA CHE SI FA VERTICALE O ORIZZONTALE. COSÌ NASCE UN NUOVO DESIGN, PERFETTA SINTESI TRA ESTETICA E FUNZIONALITÀ.

SWAY MOOD / HANGING LAMP

... **HANGING IT** ON THE CEILING, IT BRINGS LIGHT TO THE HEIGHT OF YOUR DESIRES. GRAVITY REVOLUTIONIZES THE FORM THAT BECOMES VERTICAL OR HORIZONTAL. THUS, A NEW DESIGN WAS BORN, A PERFECT SYNTHESIS OF AESTHETICS AND FUNCTIONALITY.



Articoli in foto Photo articles
modulo module: 8140 B CT
accessorio accessory: 8143 B (2 pz.)



Articoli in foto Photo articles
 modulo module:
 8136 E CT + 8138 E CT + 8140 E CT
 accessorio accessory: 8142 E (3 pz.)

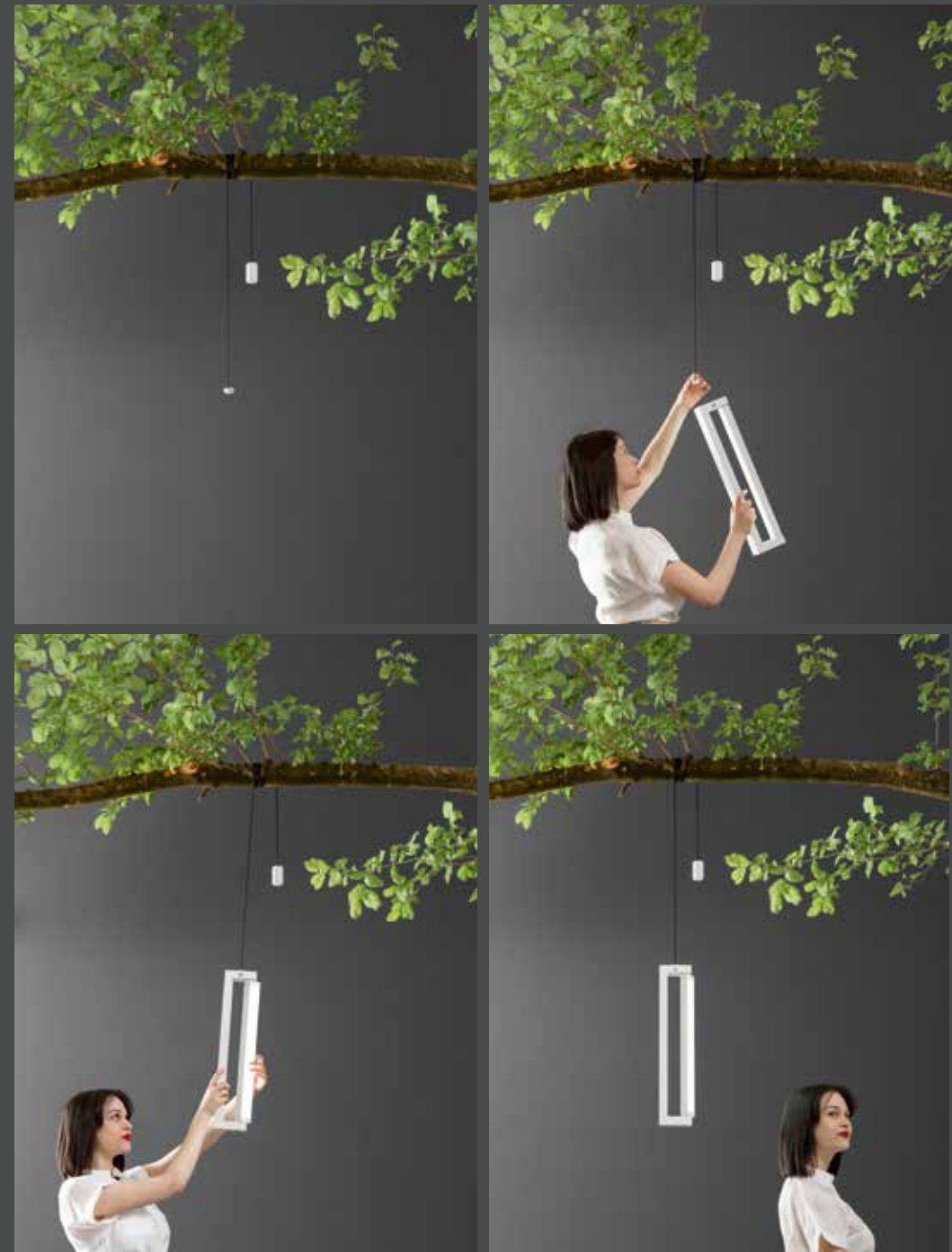

Articoli in foto Photo articles
 modulo module: 8136 B CT
 accessorio accessory: 8142 B

Informazioni tecniche Technical information p.18-19

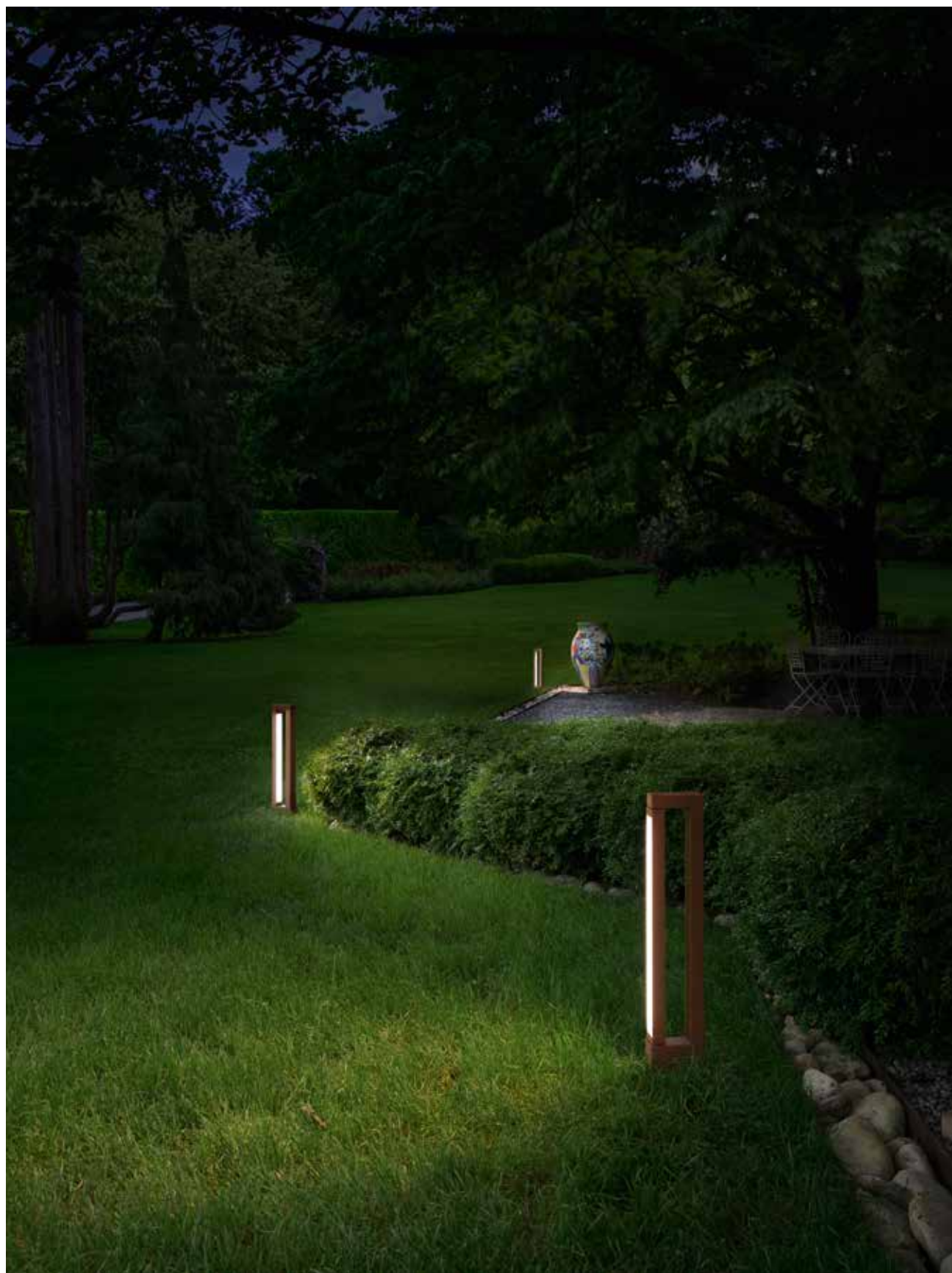

Articoli in foto Photo articles
 modulo module: 8136 E CT
 accessorio accessory: 8145 E (3 pz.)

Informazioni tecniche Technical information p.18-19

SWAY MOOD / LAMPADA DA ESTERNO

... PIANTATO COME UN FIORE LUMINOSO, REGALA AL GIARDINO UN'ATMOSFERA ELEGANTE E PULITA. LA LUCE SI DIFFONDE RENDENDO MAGICA LA SERA E RIVELANDO, A POCO A POCO, I CONTORNI DELLE COSE.

SWAY MOOD / OUTDOOR LAMP

... PLANTED LIKE A BRIGHT FLOWER, IT GIVES THE GARDEN AN ELEGANT AND CLEAN ATMOSPHERE. THE LIGHT SPREADS, MAKING THE EVENING MAGICAL AND REVEALING, LITTLE BY LITTLE, THE CONTOURS OF THINGS.



Articoli in foto Photo articles
 modulo module: 8136 B CT
 accessorio accessory: 8145 B

Informazioni tecniche Technical information p.18-19

SWAY MOOD

INFORMAZIONI TECNICHE TECHNICAL INFORMATION

Modulo orientabile a led in alluminio, ricaricabile e portatile, a batterie per uso interno/esterno. Diffusore orientabile a 300° in acrilico satinato. Interruttore touch che permette l'accensione, la regolazione dell'intensità luminosa e la selezione della temperatura di colore della luce (3000/4000/6000K).
Portable and rechargeable battery-operated swiveling LED module in aluminum for indoor/outdoor use. 300° adjustable satin acrylic diffusers. Touch switch for switching on, adjusting light intensity, and selecting light color temperature (3000/4000/ 6000K).



Accessorio incluso: carica batterie completo di cavo
Accessory included: battery charger with cable
(91CARIC8134)

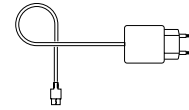

Ricambi e accessori pag.84-85
Spare parts and accessories p.84-85

LED 4W 392LM 3000/4000/6000K
Durata 7-52h in base alla regolazione della luminosità
Work time 7-52h according to the brightness adjustment
Ricarica 3h (11.1V / 3x2000mAh) batterie al litio ricaricabili e sostituibili
Recharge 3h (11.1V / 3x2000mAh) rechargeable and replaceable lithium batteries

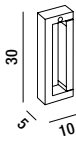

LED 6W 588LM 3000/4000/6000K
Durata 7-52h in base alla regolazione della luminosità
Work time 7-52h according to the brightness adjustment
Ricarica 6h (11.1V / 3x3000mAh) batterie al litio ricaricabili e sostituibili
Recharge 6h (11.1V / 3x3000mAh) rechargeable and replaceable lithium batteries



LED 12W 1176LM 3000/4000/6000K
Durata 7-52h in base alla regolazione della luminosità
Work time 7-52h according to the brightness adjustment
Ricarica 9h (11.1V / 6x3000mAh) batterie al litio ricaricabili e sostituibili
Recharge 9h (11.1V / 6x3000mAh) rechargeable and replaceable lithium batteries



LED 18W 1764Lm 3000/4000/6000K
Durata 7-52h in base alla regolazione della luminosità
Work time 7-52h according to the brightness adjustment
Ricarica 12h (11.1V / 9x3000mAh) batterie al litio ricaricabili e sostituibili
Recharge 12h (11.1V / 9x3000mAh) rechargeable and replaceable lithium batteries

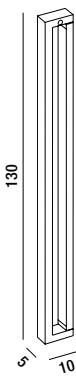

ACCESSORI ACCESSORIES

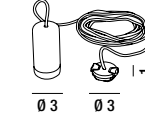
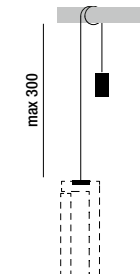

	8142 B	8142 E	8142 GS
Kit sospensione mobile Mobile hanging kit	bianco opaco matt white	corten corten	grigio scuro dark grey

Kit per trasformare SWAY MOOD in sospensione. Questo sistema è formato da un cavo in tessuto (lunghezza 3m) con ad una delle estremità un attacco rapido per fissarlo a SWAY MOOD e all'altra un contrappeso in metallo che permette di fissare facilmente la sospensione a qualsiasi struttura senza l'ausilio di nessuna ancoraggio fisso.
Kit for transforming SWAY MOOD into a hanging lamp. This system consists of a fabric cable (3m long) with a quick-release coupling at one end for attaching it to SWAY MOOD and a metal counterweight at the other end, which allows the hanging lamp to be easily attached to any structure without the need for any fixed anchorage.

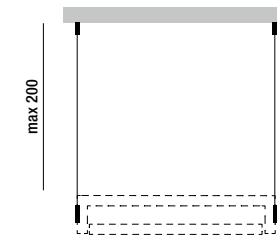

	8143 B	8143 E	8143 GS
Kit sospensione fissa Fixed hanging kit	bianco opaco matt white	corten corten	grigio scuro dark grey

Kit per trasformare SWAY MOOD in sospensione. Questo sistema è formato da un cavo in acciaio (lunghezza 2m) con ad una delle estremità un attacco rapido per fissarlo a SWAY MOOD e all'altra un bloccacavo in metallo per il fissaggio a soffitto. Per la sospensione orizzontale, come da disegno tecnico, servono 2 kit.
Kit for transforming SWAY MOOD into a hanging lamp. This system consists of a steel cable (2m long) with a quick-release coupling at one end for attaching it to SWAY MOOD and a metal cable clamp at the other end for fixing it to the ceiling. For the horizontal suspension, as technical drawing, 2 kits are needed.

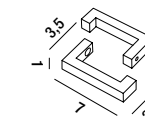
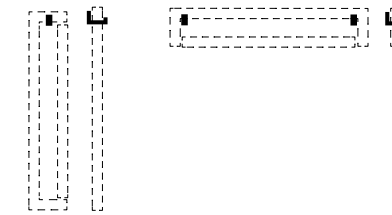

	8144 B	8144 E	8144 GS
Kit applique Wall lamp kit	bianco opaco matt white	corten corten	grigio scuro dark grey

Kit per trasformare SWAY MOOD in applique. Questo sistema è formato da due supporti in metallo da fissare a parete che consentono di appendere SWAY MOOD a muro e poter orientare la luce ruotando il diffusore del prodotto.
Kit for transforming SWAY MOOD into a wall lamp. This system consists of two metal brackets to be fixed to the wall that allow SWAY MOOD to be hung on the wall; the light can be adjusted by rotating the product diffuser.

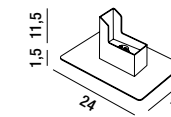

	8141 B	8141 E	8141 GS
Base di appoggio e ricarica Support and charging base	bianco opaco matt white	corten corten	grigio scuro dark grey

Base di appoggio per trasformare SWAY MOOD in lampada da terra. La base può essere utilizzata anche come stazione di ricarica a contatto, collegandola al carica batterie; è possibile inoltre utilizzare SWAY MOOD mentre è in ricarica.
Support base to transform SWAY MOOD into a floor lamp. The base can also be used as a wireless charging station by connecting it to the charger; SWAY MOOD can also be used while charging.

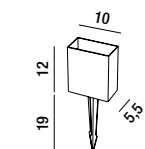
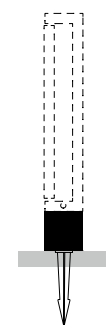

	8145 B	8145 E	8145 GS
Kit picchetto per esterno Spike kit for outdoor use	bianco opaco matt white	corten corten	grigio scuro dark grey

Accessorio per trasformare SWAY MOOD in luce da giardino. Questo supporto in metallo composta da una base di appoggio e un picchetto può essere fissato in qualsiasi terreno e permettere SWAY MOOD di diventare un comodo e orientabile paletto da esterno.
Accessory to transform SWAY MOOD into a garden light. This metal stand consisting of a base and a spike can be fixed in any terrain and allow SWAY MOOD to become a convenient, swiveling outdoor lamp post.



CONTEMPORANEA E INIMITABILE, SEDUCE E ILLUMINA I SENSI.
 IL PROFILO CONICO E ARROTONDATO CREA UN EFFETTO TATTILE
 STRAORDINARIO. IN UN ATTIMO TUTTO L'AMBIENTE SI VESTE DI UN
 NUOVO SENTIMENTO CHE RENDE INDIMENTICABILE OGNI MOMENTO.

CONTEMPORARY AND INIMITABLE, IT SEDUCES AND ENLIGHTENS THE SENSES.
 THE CONICAL, ROUNDED PROFILE CREATES AN EXTRAORDINARY
 TACTILE EFFECT. IN AN INSTANT, THE WHOLE ENVIRONMENT IS DRESSED
 IN A NEW FEELING THAT MAKES EVERY MOMENT UNFORGETTABLE.





ELLIOTT

INFORMAZIONI TECNICHE TECHNICAL INFORMATION

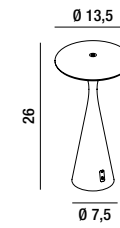

Lampada da tavolo ricaricabile a batterie in alluminio pressofuso verniciato a polvere per uso interno/esterno. Diffusore in acrilico satinato. Testina "touch" che permette l'accensione, la regolazione dell'intensità luminosa e la selezione della temperatura di colore della luce (2200/2700/3000K).

Rechargeable battery-operated table lamp made of powder-coated die-cast aluminum for indoor/outdoor use. Satin acrylic diffuser. Touch head for switching on, adjusting light intensity, and selecting light color temperature (2200/2700/3000K).

Durata 10-120h in base alla regolazione della luminosità
Work time 10-120h according to the brightness adjustment

Ricarica 5h (3.7V / 2x2200mAh) batterie al litio ricaricabili e sostituibili
Recharge 5h (3.7V / 2x2200mAh) rechargeable and replaceable lithium batteries

LED \pm 2W 190LM 2200/2700/3000K



COLORI DISPONIBILI AVAILABLE COLOURS

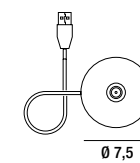

Accessorio incluso: basetta di ricarica a contatto con cavo USB (carica batterie escluso)
Accessory included: contact charging base with USB cable (battery charger excluded)

(91BAR8118)

Ricambi e accessori pag.84-85
Spare parts and accessories p.84-85

MINI ELLIOTT

AGILE E DIVERTENTE, PER GLI AMANTI DEL MINIMAL.
CON LA SUA SAGOMA ELEGANTE VOLA NELLO SPAZIO COME
UNA FARFALLA. LA PICCOLA DIMENSIONE LE PERMETTE DI
POSARSI LADDOVE SERVE E ILLUMINARE IN POCHI SECONDI
UNA SITUAZIONE MAGICA E INASPETTATA.

SLEEK AND FUN, FOR LOVERS OF MINIMALISM.
WITH ITS ELEGANT SILHOUETTE IT FLIES THROUGH SPACE
LIKE A BUTTERFLY. ITS SMALL SIZE ALLOWS IT TO BE
PLACED WHERE IT IS NEEDED AND TO SHED LIGHT ON
AN UNEXPECTED, MAGICAL SITUATION IN SECONDS.

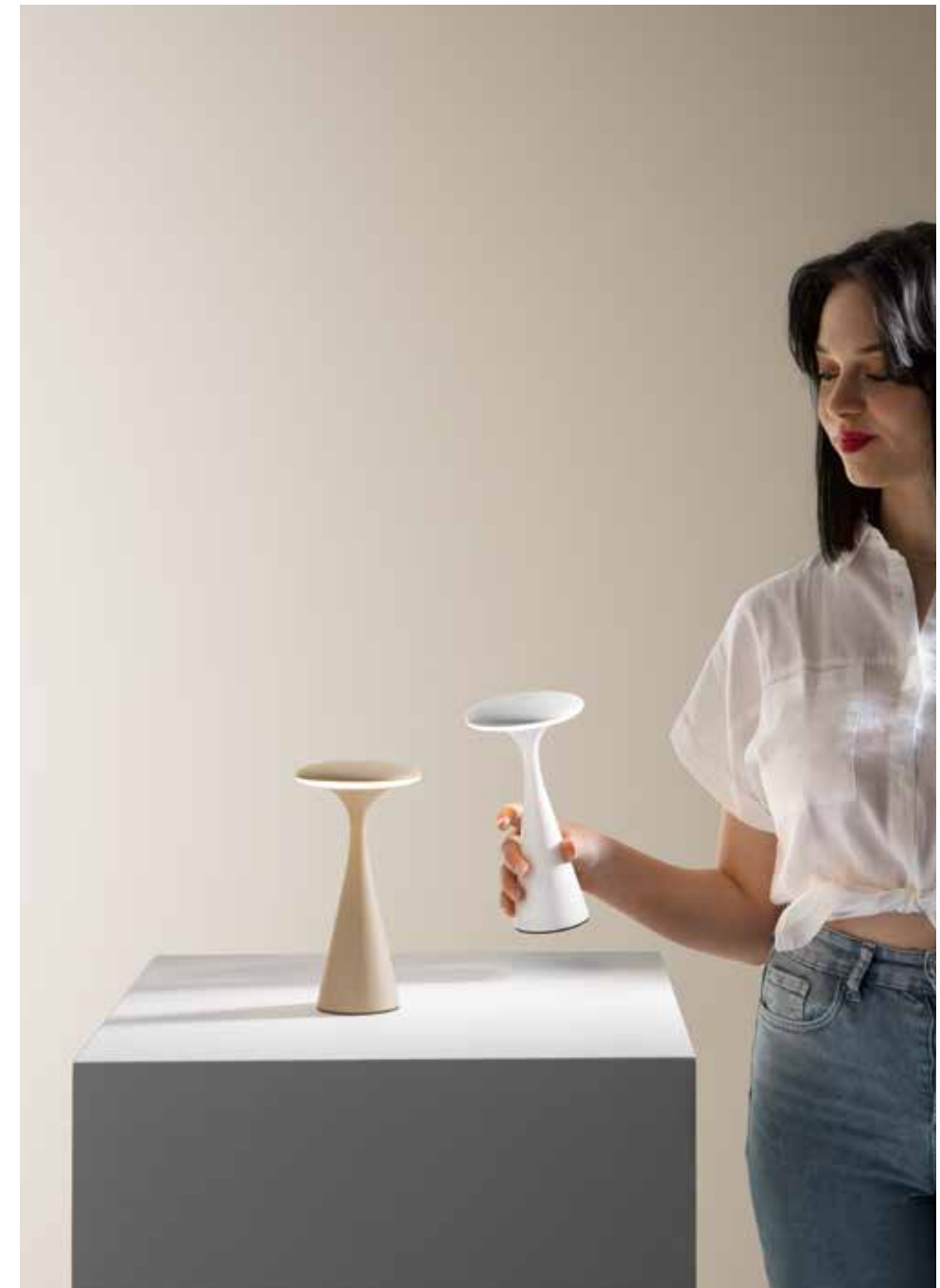



MINI ELLIOTT

INFORMAZIONI TECNICHE TECHNICAL INFORMATION

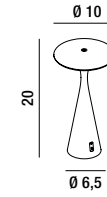

Lampada da tavolo ricaricabile a batterie in alluminio pressofuso verniciato a polvere per uso interno/esterno. Diffusore in acrilico satinato. Testina "touch" che permette l'accensione, la regolazione dell'intensità luminosa e la selezione della temperatura di colore della luce (2200/2700/3000K).
Rechargeable battery-operated table lamp made of powder-coated die-cast aluminum for indoor/outdoor use. Satin acrylic diffuser. Touch head for switching on, adjusting light intensity, and selecting light color temperature (2200/2700/3000K).

Durata 8-90h in base alla regolazione della luminosità
Work time 8-90h according to the brightness adjustment

Ricarica 3h (3.7V / 2600mAh) batterie al litio ricaricabili e sostituibili
Recharge 3h (3.7V / 2600mAh) rechargeable and replaceable lithium batteries

LED \approx 1,5W 140LM 2200/2700/3000K



COLORI DISPONIBILI AVAILABLE COLOURS

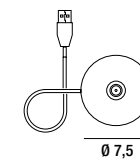

Accessorio incluso: basetta di ricarica a contatto con cavo USB (carica batterie escluso)
Accessory included: contact charging base with USB cable (battery charger excluded)

(91BAR8118)

Ricambi e accessori pag.84-85
Spare parts and accessories p.84-85

PINUP



ELEGANTE E RAFFINATA, IPNOTIZZA AL PRIMO SGUARDO.
UN VERO OGGETTO DI DESIGN CAPACE DI TRASFORMARE L'INTERO
AMBIENTE CON IL SUO SOFFIO DI LUCE. LA TESTINA TOUCH REGALA
IN UN ATTIMO UN'ESPERIENZA VISIVA E SENSORIALE SENZA EGUALI.

ELEGANT AND REFINED, IT MESMERIZES AT FIRST GLANCE.
AN AUTHENTIC DESIGN OBJECT CAPABLE OF TRANSFORMING THE
ENTIRE ROOM WITH ITS BREATH OF LIGHT. THE TOUCH HEAD PROVIDES
AN UNPARALLELED VISUAL AND SENSORY EXPERIENCE IN AN INSTANT.





PINUP

INFORMAZIONI TECNICHE TECHNICAL INFORMATION

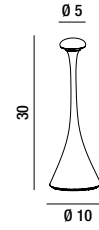

Lampada da tavolo ricaricabile a batterie in alluminio pressofuso verniciato a polvere per uso interno/esterno. Diffusore in acrilico satinato. Testina "touch" che permette l'accensione, la regolazione dell'intensità luminosa e la selezione della temperatura di colore della luce (2700/3000K).

Rechargeable battery-operated table lamp made of powder-coated die-cast aluminum for indoor/outdoor use. Satin acrylic diffuser. Touch head for switching on, adjusting light intensity, and selecting light color temperature (2700/3000K).

Durata 12h alla massima potenza
Work time 12h at full power

Ricarica 6h (3.7V / 2x4400mAh)
batterie al litio ricaricabili e sostituibili
Recharge 6h (3.7V / 2x4400mAh)
rechargeable and replaceable lithium batteries

LED \approx 2,2W 187LM 2700/3000K



COLORI DISPONIBILI AVAILABLE COLOURS

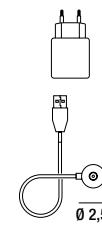

Accessorio incluso: basetta di ricarica a contatto con cavo USB e carica batterie
Accessory included: contact charging base with USB cable and battery charger included.

(91BAR8112 + 91CARIC6910)

Ricambi e accessori pag.84-85
Spare parts and accessories p.84-85

DIVA



ICONICA E INCONFONDIBILE, ARREDA QUALSIASI AMBIENTE.
 IL DISEGNO UNICO LA RENDONO UN OGGETTO PER VERI INTENDITORI.
 CON UN TOCCO LIEVE ILLUMINA E DIFFONDE UNA LUCE SOFFUSA E
 SOFISTICATA PER UN ROMANTICISMO IRRESISTIBILE.

ICONIC AND UNMISTAKABLE, IT FURNISHES ANY ENVIRONMENT.
 THE UNIQUE DESIGN MAKES IT AN OBJECT FOR TRUE CONNOISSEURS.
 WITH A LIGHT TOUCH IT ILLUMINATES AND DIFFUSES A SOFT,
 SOPHISTICATED LIGHT FOR IRRESISTIBLE ROMANCE.





DIVA

INFORMAZIONI TECNICHE TECHNICAL INFORMATION

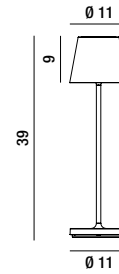

Lampada da tavolo ricaricabile a batterie in alluminio pressofuso verniciato a polvere per uso interno/esterno. Diffusore in acrilico satinato. Testina "touch" che permette l'accensione e la regolazione dell'intensità luminosa.
Rechargeable battery-operated table lamp made of powder-coated die-cast aluminum for indoor/outdoor use. Satin acrylic diffuser. Touch head for switching on and adjusting light intensity.

Durata 10h alla massima potenza
Work time 10h at full power

Ricarica 6h (3.7V / 2x2200mAh)
batterie al litio ricaricabili e sostituibili
Recharge 6h (3.7V / 2x2200mAh)
rechargeable and replaceable lithium batteries

LED \varnothing 2W 190LM 3000K



COLORI DISPONIBILI AVAILABLE COLOURS

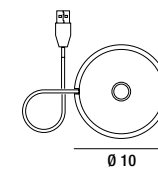

Accessorio incluso: basetta di ricarica a contatto con cavo USB (carica batterie escluso)
Accessory included: contact charging base with USB cable (battery charger excluded)

(91BAR8124)

Ricambi e accessori pag.84-85
Spare parts and accessories p.84-85

MINI DIVA

UN PUNTO LUCE PICCOLO E DELICATO MA DALLA FORMA INCONFONDIBILE. ADATTA AD UN UTILIZZO DINAMICO DELLA LUCE, FACILMENTE TRASPORTABILE, PUÒ ILLUMINARE ALL'INTERNO E ALL'ESTERNO OGNI SITUAZIONE DELLA GIORNATA. IDEALE PER CHI HA POCO SPAZIO MA VUOLE ESSERE AL PASSO COI TEMPI.

A SMALL AND DELICATE LIGHT BUT WITH AN UNMISTAKABLE SHAPE. SUITABLE FOR A DYNAMIC USE OF LIGHT, EASILY TRANSPORTABLE, IT CAN LIGHT UP EVERY SITUATION OF THE DAY INSIDE AND OUT. IDEAL FOR THOSE WHO HAVE LITTLE SPACE BUT WANT TO BE UP WITH THE TIMES.





MINI DIVA

INFORMAZIONI TECNICHE
TECHNICAL INFORMATION

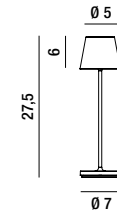

Lampada da tavolo ricaricabile a batterie in alluminio pressofuso verniciato a polvere per uso interno/esterno. Diffusore in acrilico satinato. Testina "touch" che permette l'accensione e la regolazione dell'intensità luminosa.
Rechargeable battery-operated table lamp made of powder-coated die-cast aluminum for indoor/outdoor use. Satin acrylic diffuser. Touch head for switching on and adjusting light intensity.

Durata 10h alla massima potenza
Work time 10h at full power

Ricarica 3h (3.7V / 2x1900mAh)
batterie al litio ricaricabili e sostituibili
Recharge 3h (3.7V / 2x1900mAh)
rechargeable and replaceable lithium batteries

LED 1,5W 140LM 3000K



COLORI DISPONIBILI
AVAILABLE COLOURS

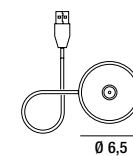

Accessorio incluso: basetta di ricarica a contatto con cavo USB (carica batterie escluso)
Accessory included: contact charging base with USB cable (battery charger excluded)

(91BAR8125)

Ricambi e accessori pag.84-85
Spare parts and accessories p.84-85

ETOILE



**SCHIETTA E TRASPARENTE,
AVVOLGE TUTTO LO SPAZIO.
UNA NATURA INTIMA E DELICATA
CHE FA FILTRARE LA LUCE
ATTRAVERSO UN VELO. IL VETRO
INONDA L'AMBIENTE DI DOLCEZZA
SFUMANDO I CONTORNI E
VALORIZZANDO I DETTAGLI.**

**CLEAR AND TRANSPARENT, IT
ENVELOPS THE WHOLE SPACE.
AN INTIMATE AND DELICATE
NATURE THAT ALLOWS LIGHT
TO FILTER THROUGH A VEIL.
GLASS FLOODS THE ROOM WITH
SOFTNESS, BLURRING CONTOURS
AND ENHANCING DETAILS.**





ETOILE

INFORMAZIONI TECNICHE TECHNICAL INFORMATION

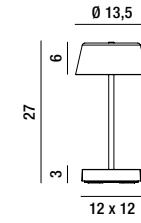

Lampada da tavolo ricaricabile a batterie in alluminio pressofuso verniciato a polvere per uso interno/esterno. Diffusore in vetro soffiato trasparente (borosilicato). Interruttore touch sulla base che permette l'accensione, la regolazione dell'intensità luminosa e la selezione della temperatura di colore della luce (2700/3000K).

Rechargeable battery-operated table lamp made of powder-coated die-cast aluminum for indoor/outdoor use. Transparent blown glass diffuser (borosilicate). Touch switch on the base for switching on, adjusting light intensity, and selecting light color temperature (2700/3000K).

LED \varnothing 2,5W 220LM 2700/3000K

Durata 10h alla massima potenza
Work time 10h at full power

Ricarica 6h (3.7V / 2x4400mAh)
batterie al litio ricaricabili e sostituibili
Recharge 6h (3.7V / 2x4400mAh)
rechargeable and replaceable lithium batteries



COLORI DISPONIBILI AVAILABLE COLOURS

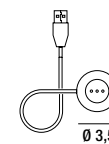

Accessorio incluso: basetta di ricarica a contatto con cavo USB (carica batterie escluso)
Accessory included: contact charging base with USB cable (battery charger excluded)

(91BAR8126)

Ricambi e accessori pag.84-85
Spare parts and accessories p.84-85

KONDA

REGISTERED DESIGN



ESSENZIALE E MINIMALISTA, UN INNO ALLA LEGGEREZZA. UN CIRCUITO SINUOSO CHE SEDUCE COME LA CODA DI UN SERPENTE E VALORIZZA LO SPAZIO VUOTO. LA LUCE CHE SI ESPANDE È COSÌ LEGGERA E RAREFATTA CHE OGNI ANGOLO LA RECLAMA.

ESSENTIAL AND MINIMALIST, AN ODE TO LIGHTNESS. A SINUOUS CIRCUIT THAT SEDUCES LIKE A SNAKE'S TAIL AND ENHANCES EMPTY SPACE. THE LIGHT THAT SPREADS OUT IS SO GENTLE AND RAREFIED THAT EVERY CORNER CLAIMS IT.





TRASFORMA LA PIANTANA KONDA CON L'AGGIUNTA DI UN SEMPLICE ACCESSORIO (8115 N - PICCHETTO METALLO) IN UNA COMODA ED ORIENTABILE LUCE DA GIARDINO.

TRANSFORM THE KONDA FLOOR LAMP WITH THE ADDITION ACCESSORY (8115 N - METAL SPIKE) INTO A COMFORTABLE AND ADJUSTABLE GARDEN LIGHT.

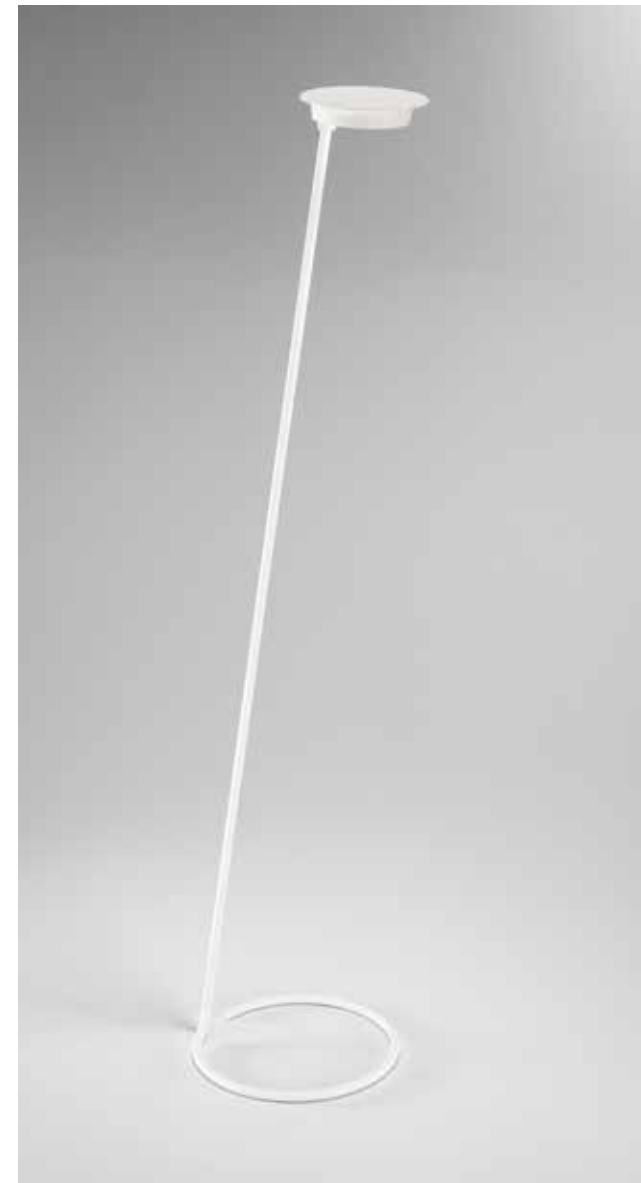

Articolo in foto Photo article
8116 B LC

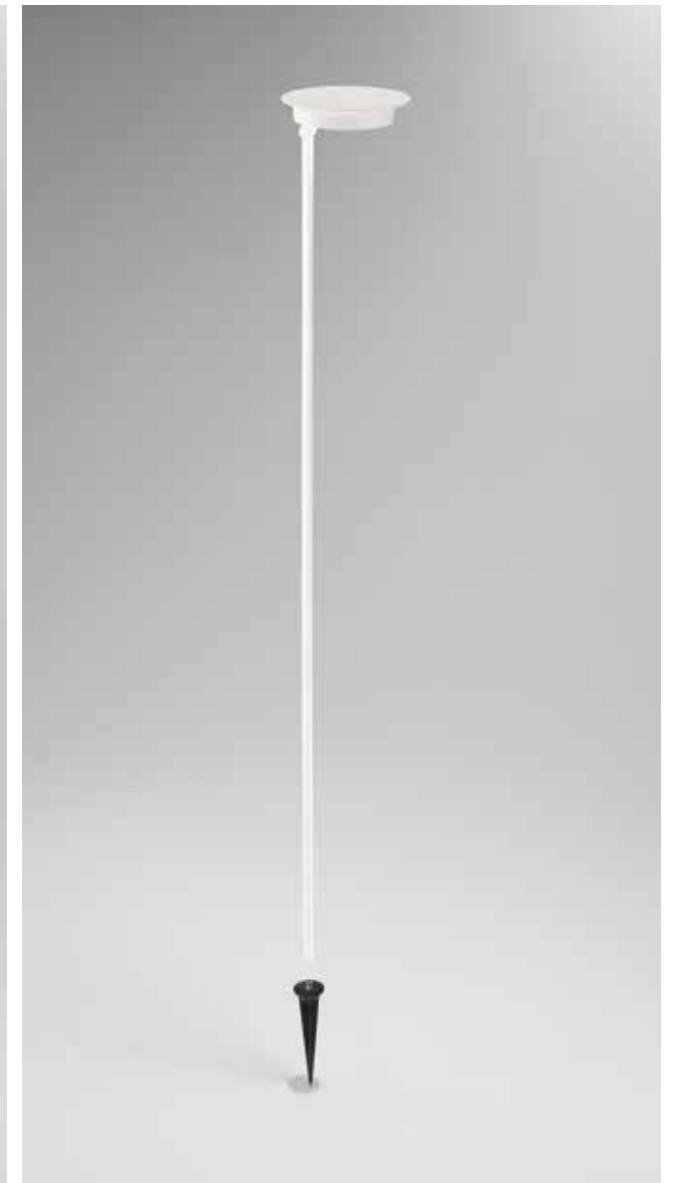

Articolo in foto Photo article
8116 B LC + 8115 N

KONDA

INFORMAZIONI TECNICHE
TECHNICAL INFORMATION

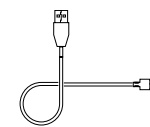
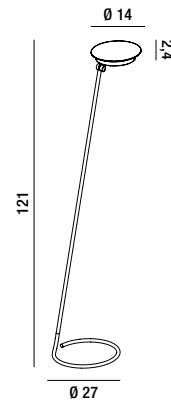
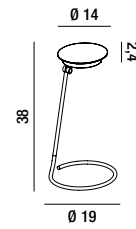

Accessorio incluso: cavo USB per ricarica (carica batterie escluso)
Accessory included: USB charging cable (battery charger excluded)

(91CAV8114)

Ricambi e accessori pag.84-85
Spare parts and accessories p.84-85

Lampada da tavolo ricaricabile a batterie in metallo e Abs verniciato per uso interno/esterno. Diffusore orientabile in acrilico satinato. Testina "touch" che permette l'accensione e la regolazione dell'intensità luminosa.
Rechargeable battery-operated table lamp made of metal and painted ABS for indoor/outdoor use. Adjustable satin acrylic diffuser. Touch head for switching on and adjusting light intensity.

Durata 7-120h
in base alla regolazione della luminosità
Work time 7-120h
according to the brightness adjustment

Ricarica 3h (3.7V / 2x2000mAh)
batterie al litio ricaricabili e sostituibili
Recharge 3h (3.7V / 2x2000mAh)
rechargeable and replaceable lithium batteries



LED \approx 2,5W 160LM 3000K

Lampada da terra ricaricabile a batterie in metallo e Abs verniciato per uso interno/esterno. Diffusore orientabile in acrilico satinato. Testina "touch" che permette l'accensione e la regolazione dell'intensità luminosa.
Rechargeable battery-operated floor lamp made of metal and painted ABS for indoor/outdoor use. Adjustable satin acrylic diffuser. Touch head for switching on and adjusting light intensity.

Durata 7-120h
in base alla regolazione della luminosità
Work time 7-120h
according to the brightness adjustment

Ricarica 3h (3.7V / 2x2000mAh)
batterie al litio ricaricabili e sostituibili
Recharge 3h (3.7V / 2x2000mAh)
rechargeable and replaceable lithium batteries



LED \approx 2,5W 160LM 3000K

Picchetto in metallo per trasformare KONDA in luce da giardino. Questo supporto può essere fissato in qualsiasi terreno e permettere a KONDA di diventare un comodo e orientabile paletto da esterno.
Metal spike to transform KONDA into a garden light. This stand can be fixed in any terrain and allows KONDA to become a convenient, swiveling outdoor lamp post.

COLORI DISPONIBILI
AVAILABLE COLOURS

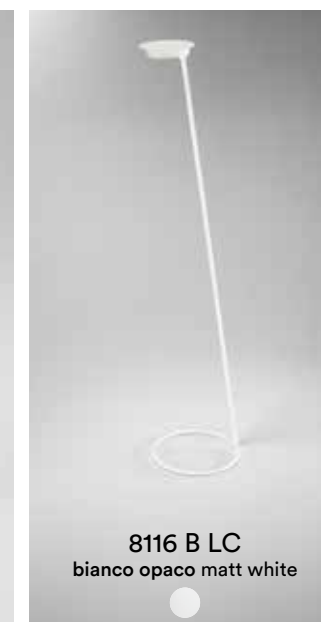

SOAP

RICERCATA E ORIGINALE, NON SMETTE DI STUPIRE.
 DOPPIA ANIMA LUMINOSA GRAZIE AL DIFFUSORE TRASPARENTE E SATINATO. IN UN MOMENTO LA LUCE A BIEMISSIONE RIDEFINISCE LO SPAZIO VESTENDOLO DI UN'ATMOSFERA CALDA E SUGGESTIVA.

SOPHISTICATED AND ORIGINAL, IT NEVER CEASES TO AMAZE.
 DOUBLE LUMINOUS SOUL THANKS TO THE TRANSPARENT AND SATIN-FINISHED DIFFUSER. IN A MOMENT, THE BI-EMISSION LIGHT REDEFINES THE SPACE, DRESSING IT IN A WARM AND EVOCATIVE ATMOSPHERE.





SOAP

INFORMAZIONI TECNICHE
TECHNICAL INFORMATION

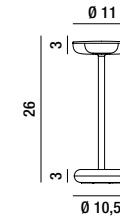

Lampada da tavolo ricaricabile a batterie in metallo e Abs verniciato per uso interno/esterno. Doppio diffusore in acrilico trasparente all'esterno e satinato all'interno. Interruttore touch sulla base che permette l'accensione e la regolazione dell'intensità luminosa.

Rechargeable battery-operated table lamp made of metal and painted ABS for indoor/outdoor use. Double diffuser made of transparent acrylic on the outside and satin acrylic on the inside. Touch head on the base for switching on and adjusting light intensity.

Durata 7h alla massima potenza
Work time 7h at full power

Ricarica 4h (3.7V / 1800mAh)
batterie al litio ricaricabili e sostituibili
Recharge 4h (3.7V / 1800mAh)
rechargeable and replaceable lithium batteries

LED 2W 188LM 3000K



COLORI DISPONIBILI
AVAILABLE COLOURS

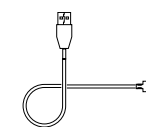

Accessorio incluso: cavo USB per ricarica (carica batterie escluso)
Accessory included: USB charging cable (battery charger excluded)

(91CAV8122)

Ricambi e accessori pag.84-85
Spare parts and accessories p.84-85

ASTRO



DINAMICA E SOFISTICATA, SEMPRE PRONTA A SORPRENDERE.
 IL DISCO INCLINATO RENDE OBLIQUA LA LUCE E GENERA UN'ATMOSFERA
 DALLE MILLE GRADAZIONI. IMMEDIATAMENTE LO SPAZIO ABBRACCIA
 QUALSIASI OGGETTO REGALANDOGLI UNA NUOVA PROSPETTIVA.

DYNAMIC AND SOPHISTICATED, ALWAYS READY TO AMAZE.
 THE TILTED DISC MAKES THE LIGHT OBLIQUE AND GENERATES AN
 ATMOSPHERE OF A THOUSAND SHADES. IMMEDIATELY THE SPACE
 EMBRACES ANY OBJECT, GIVING IT A NEW PERSPECTIVE.





ASTRO

INFORMAZIONI TECNICHE
TECHNICAL INFORMATION

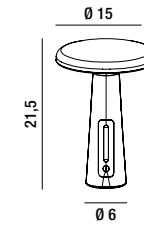

Lampada da tavolo ricaricabile a batterie in metallo e Abs verniciato per uso interno/esterno.
Diffusore orientabile in acrilico satinato.
Interruttore touch sulla base che permette l'accensione e la regolazione dell'intensità luminosa.
Rechargeable battery-operated table lamp made of metal and painted ABS for indoor/outdoor use.
Adjustable satin acrylic diffuser. Touch head on the base for switching on and adjusting light intensity.

Durata 8h alla massima potenza
Work time 8h at full power

Ricarica 4h (3.7V / 3000mAh)
batterie al litio ricaricabili e sostituibili
Recharge 4h (3.7V / 3000mAh)
rechargeable and replaceable lithium batteries

LED 4W 160LM 3000K



COLORI DISPONIBILI
AVAILABLE COLOURS

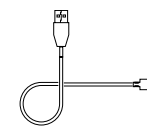

Accessorio incluso: cavo USB per ricarica (carica batterie escluso)
Accessory included: USB charging cable (battery charger excluded)

(91CAV8132)

Ricambi e accessori pag.84-85
Spare parts and accessories p.84-85

MANHATTAN



**VERSATILE E GIOCOSA, APRE NUOVE VISIONI.
UN FUNGO LUMINOSO DA PORTARE OVUNQUE CHE SI ADATTA AD OGNI
STILE DI ARREDO. IL GESTO SEMPLICE DI UNO SFIORO E IN UN ATTIMO
LO SPAZIO SI COLORA OFFRENDO UN'EMOZIONE INASPETTATA.**

**VERSATILE AND PLAYFUL, IT OPENS UP NEW VISIONS.
A LUMINOUS MUSHROOM THAT CAN BE TAKEN ANYWHERE AND SUITS ANY
STYLE OF DÉCOR. THE SIMPLE GESTURE OF A BRUSHSTROKE AND IN AN
INSTANT THE SPACE IS COLORED, OFFERING AN UNEXPECTED EMOTION.**





MANHATTAN

INFORMAZIONI TECNICHE
TECHNICAL INFORMATION

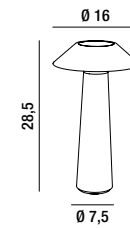

Lampada da tavolo ricaricabile a batterie in metallo e Abs verniciato per uso interno/esterno. Doppio diffusore in acrilico trasparente all'esterno e satinato all'interno. Testina "touch" che permette l'accensione e la regolazione dell'intensità luminosa.
Rechargeable battery-operated table lamp made of metal and painted ABS for indoor/outdoor use. Double diffuser made of transparent acrylic on the outside and satin acrylic on the inside. Touch head for switching on and adjusting light intensity.

Durata 8h alla massima potenza
Work time 8h at full power

Ricarica 4h (3.7V / 2200mAh)
batterie al litio ricaricabili e sostituibili
Recharge 4h (3.7V / 2200mAh)
rechargeable and replaceable lithium batteries

LED 2W 160LM 3000K



COLORI DISPONIBILI
AVAILABLE COLOURS

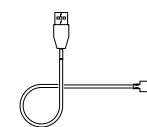

Accessorio incluso: cavo USB per ricarica (carica batterie escluso)
Accessory included: USB charging cable (battery charger excluded)

(91CAV8120)

Ricambi e accessori pag.84-85
Spare parts and accessories p.84-85

KOSMO



8076 B LC 8076 N LC

bianco opaco
matt white



nero opaco
matt black



Lampada da tavolo ricaricabile in metallo e alluminio con testina in plastica orientabile. Testina removibile (attacco magnetico) che può essere utilizzata come luce mobile o come luce da parete applicandola al supporto in dotazione. Interruttore touch sulla testina (dimmerabile 3 step). Supporto a parete + carica batteria + cavo USB inclusi.

Metal and aluminium rechargeable table lamp with swivelling plastic head. Removable head (magnetic connection) that can be used as a hand light or as a wall light by attaching it to the bracket provided. Touch switch on the head (dimnable 3 step). Wall bracket + battery charger + USB cable included.

Durata 4h alla massima potenza
Work time 4h at full power

Ricarica 4h (3.7V / 1800mAh)
batterie al litio ricaricabili e sostituibili
Recharge 4h (3.7V / 1800mAh)
rechargeable and replaceable lithium batteries

Accessorio incluso: cavo USB
per ricarica e carica batterie
Accessory included: USB charging
cable and battery charger

(91CAV8076 + 91CARIC8076)

Ricambi e accessori pag.84-85
Spare parts and accessories p.84-85

LED 3W 180LM 3000K

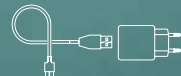

MAGNET

REGISTERED DESIGN



PORTA USB
PER RICARICA
USB CHARGING
PORT

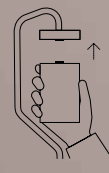

SUPPORTO CON
INTERFACCIA/DISCO
DOVE È PRESENTE
IL MAGNETE
SUPPORT WITH
INTERFACE/DISC
WHERE THERE IS
THE MAGNET

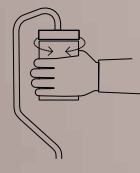

IL MAGNETE HA LA FUNZIONE DI CONNETTERE IL CORPO
ILLUMINANTE ALLA STRUTTURA DEL PRODOTTO. L'ACCENSIONE
ON/OFF AVVIENE CON LA SEMPLICE ROTAZIONE DELLA TESTINA
(MECCANISMO DI ACCENSIONE SENZA INTERRUTTORE)
THE MAGNET HAS THE FUNCTION OF CONNECTING
THE LIGHTING BODY TO THE STRUCTURE OF THE PRODUCT.
TO TURN IT ON/OFF YOU JUST NEED TO ROTATE THE
HEAD (POWER-ON MECHANISM WITHOUT SWITCH)

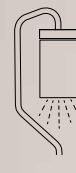

ACCENSIONE
AND IT GOES ON



MAGNET 6910 / LAMPADA TAVOLO.
AGGANCIA IL CORPO ILLUMINANTE ALLO STELO
SAGOMATO DI MAGNET. CREI UNA LAMPADA DA TAVOLO
RICARICABILE DA POSIZIONARE DOVE VUOI TU.

MAGNET 6910 / TABLE LAMP.
SNAP THE LIGHTING BODY TO THE SHAPED STEM
OF MAGNET. YOU CREATE A RECHARGEABLE
TABLE LAMP TO BE PLACED WHEREVER YOU WANT.



MAGNET 6914 B / KIT PARETE + RICARICA.
 FISSA LA STAFFA IN QUALSIASI PUNTO DELLA PARETE E
 ACCENDI LA MAGNET - APPLIQUE IN UN SEMPLICE GESTO.

MAGNET 6914 B / KIT PARETE + RICARICA.
 FIX THE BRACKET ANYWHERE ON THE WALL AND
 TURN ON MAGNET - WALL LAMP IN ONE EASY STEP.



3 PORTE USB PER RICARICA
 (FUNZIONANO SOLAMENTE
 SE LA BASE DELL'APPLIQUE
 VIENE ELETTRIFICATA)
 3 USB CHARGING PORTS
 (THEY ONLY WORK IF THE
 BASE OF THE APPLIQUE IS
 ELECTRIFIED)

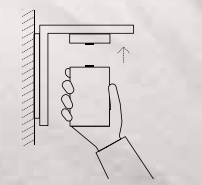

**SUPPORTO CON
 INTERFACCIA/DISCO**
 DOVE È PRESENTE
 IL MAGNETE
 SUPPORT WITH
 INTERFACE/DISC
 WHERE THERE
 IS THE MAGNET

**IL MAGNETE HA LA FUNZIONE DI CONNETTERE
 IL CORPO ILLUMINANTE ALLA STRUTTURA DEL
 PRODOTTO. L'ACCENSIONE ON/OFF AVVIENE
 CON LA SEMPLICE ROTAZIONE DELLA TESTINA
 (MECCANISMO DI ACCENSIONE SENZA INTERRUTTORE)**
 THE MAGNET HAS THE FUNCTION OF CONNECTING
 THE LIGHTING BODY TO THE STRUCTURE OF THE
 PRODUCT. TO TURN IT ON/OFF YOU JUST NEED
 TO ROTATE THE HEAD (POWER-ON MECHANISM
 WITHOUT SWITCH)

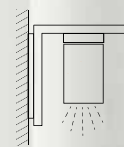
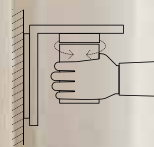

**ACCENSIONE
 AND IT GOES ON**



MAGNET 6918 B / ACCESSORIO TORCIA.
 PORTA LA LUCE CON TE! CONNETTENDO IL
 CORPO ILLUMINANTE AL DISCO MAGNETICO
 MAGNET È UNA COMODA TORCIA.

MAGNET 6918 B / FLASHLIGHT ACCESSORY.
 BRING LIGHT WITH YOU! BY CONNECTING
 THE LIGHTING BODY TO THE MAGNETIC DISK
 MAGNET IS A HANDY TORCH.

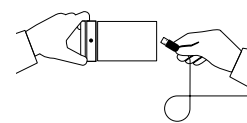

PORTA USB PER RICARICA
 USB CHARGING PORT

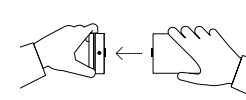

**SUPPORTO CON
 INTERFACCIA/DISCO DOVE
 È PRESENTE IL MAGNETE**
 SUPPORT WITH
 INTERFACE/DISC WHERE
 THERE IS THE MAGNET

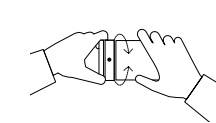

**IL MAGNETE HA LA FUNZIONE DI CONNETTERE IL
 CORPO ILLUMINANTE ALLA STRUTTURA DEL PRODOTTO.**
 L'ACCENSIONE ON/OFF AVVIENE CON LA SEMPLICE
 ROTAZIONE DELLA TESTINA (MECCANISMO DI
 ACCENSIONE SENZA INTERRUTTORE)
 THE MAGNET HAS THE FUNCTION OF CONNECTING
 THE LIGHTING BODY TO THE STRUCTURE OF THE
 PRODUCT. TO TURN IT ON/OFF YOU JUST NEED TO ROTATE THE
 HEAD (POWER-ON MECHANISM WITHOUT SWITCH)



**ACCENSIONE
 AND IT GOES ON**



MAGNET 6912 B / ACCESSORIO SOSPENSIONE.
UNISCI L'APPOSITO CORDINO CON CONTRAPPESO AL CILINDRO PER TRASFORMARE VELOCEMENTE MAGNET IN UNA SOSPENSIONE DA APPENDERE OVUNQUE TU DESIDERI.

MAGNET 6912 B / SUSPENSION ACCESSORY.
COMBINE THE SPECIAL CORD WITH COUNTERWEIGHT TO THE CYLINDER TO QUICKLY TURN MAGNET INTO A HANGING LAMP TO HANG WHEREVER YOU WANT.

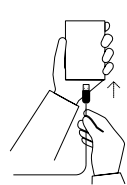

PORTA USB
PER RICARICA
USB CHARGING
PORT

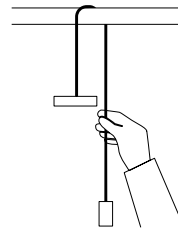

LA STRUTTURA VIENE
FISSATA TRAMITE IL
CAVO DOTATO DEL
CONTRAPPESO
IN METALLO
THE STRUCTURE IS
FIXED BY THE CABLE
FITTED WITH A METAL
COUNTERWEIGHT

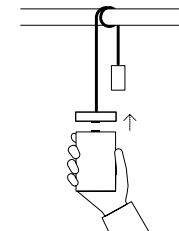

SUPPORTO CON
INTERFACCIA/DISCO
DOVE È PRESENTE
IL MAGNETE
SUPPORT WITH
INTERFACE/DISC
WHERE THERE IS
THE MAGNET

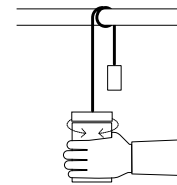

IL MAGNETE HA LA FUNZIONE DI CONNETTERE
IL CORPO ILLUMINANTE ALLA STRUTTURA DEL
PRODOTTO. L'ACCENSIONE ON/OFF AVVIENE CON LA
SEMPLICE ROTAZIONE DELLA TESTINA (MECCANISMO
DI ACCENSIONE SENZA INTERRUTTORE)
THE MAGNET HAS THE FUNCTION OF CONNECTING THE
LIGHTING BODY TO THE STRUCTURE OF THE PRODUCT.
TO TURN IT ON/OFF YOU JUST NEED TO ROTATE THE
HEAD (POWER-ON MECHANISM WITHOUT SWITCH)

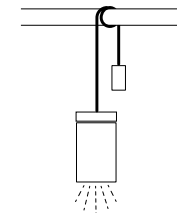

ACCENSIONE
AND IT GOES ON



MAGNET

INFORMAZIONI TECNICHE
TECHNICAL INFORMATION



SCOPRI IL VIDEO MAGNET
DISCOVER MAGNET'S VIDEO

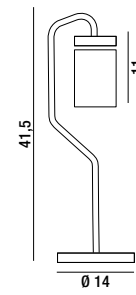

6910 B

bianco opaco
matt white



6910 E

corten
corten



6910 N

nero opaco
matt black



Lampada da tavolo a LED costruito in alluminio pressofuso verniciato a polvere con pre-trattamento per uso esterno/interno. Interruttore a rotazione a magneti.
LED table lamp built in powder coated die-cast aluminum with pre-treatment for outdoor/indoor use. Magnet rotary switch.

Durata 9h alla massima potenza
Work time 9h at full power

Ricarica 7h (3.7V / 2x2200mAh) batterie al litio ricaricabili e sostituibili
Recharge 7h (3.7V / 2x2200mAh) rechargeable and replaceable lithium batteries

LED $\hat{=}$ 2,2W 255LM 3000K



Accessorio incluso: cavo USB per ricarica e carica batterie
Accessory included: USB charging cable and battery charger (91CAV6910 + 91CARIC6910)

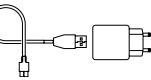

Ricambi e accessori pag.84-85
Spare parts and accessories p.84-85

ACCESSORI ACCESSORIES



Kit luce
Light kit

6916 B

bianco opaco
matt white



Kit luce a LED costruito in alluminio pressofuso verniciato a polvere con pre-trattamento per uso esterno/interno. Interruttore a rotazione a magneti.
LED light kit built in powder coated die-cast aluminum with pre-treatment for outdoor/indoor use. Magnet rotary switch.

Durata 9h alla massima potenza
Work time 9h at full power

Ricarica 7h (3.7V / 2x2200mAh) batterie al litio ricaricabili e sostituibili
Recharge 7h (3.7V / 2x2200mAh) rechargeable and replaceable lithium batteries

LED $\hat{=}$ 2,2W 255LM 3000K



Accessorio incluso: cavo USB per ricarica e carica batterie
Accessory included: USB charging cable and battery charger (91CAV6910 + 91CARIC6910)

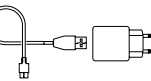

Ricambi e accessori pag.84-85
Spare parts and accessories p.84-85

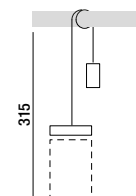

Kit sospensione mobile
Mobile hanging kit

6912 B

bianco opaco
matt white



Kit sospensione costruita in alluminio pressofuso verniciato a polvere con pre-trattamento per uso esterno/interno. 3m di cavo nero, dotata di magneti che permettono il collegamento del kit luce art. 6916.
Suspension kit made of die-cast aluminum powder coated with pre-treatment for outdoor/indoor use. 3m of black cable, equipped with magnets that allow the connection of the light kit with art. 6916.

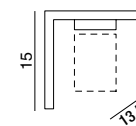

Kit applique
Wall lamp kit

6914 B

bianco opaco
matt white



Kit applique realizzata in alluminio pressofuso verniciato a polvere con pre-trattamento per uso esterno/interno. 3 porte USB, dotata di magneti che permettono il collegamento del kit luce art. 6916.
Wall kit built in powder coated die-cast aluminum with pre-treatment for outdoor/indoor use. 3 port USB, equipped with magnets that allow the connection of the light kit with art. 6916.

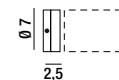

Kit torcia
Flashlight

6918 B

bianco opaco
matt white



Kit torcia realizzata in alluminio pressofuso verniciato a polvere con pre-trattamento per uso esterno/interno. Dotata di magneti che permettono il collegamento del kit luce art. 6916.
Flashlight accessory built in powder coated die-cast aluminum with pre-treatment for outdoor/indoor use. Equipped with magnets that allow the connection of the light kit with art. 6916.

CAGE



RIGOROSA E GEOMETRICA, PER UN EFFETTO MAGICO.
LINEE PERPENDICOLARI E UNA FORMA GEOMETRICA PURA
CHE SEZIONA LO SPAZIO PER UN VERO E PROPRIO "EFFETTO
MAGIA". UNA LANTERNA MODERNA DA PORTARE CON TE E
POSIZIONARE DOVE VUOI.

RIGOROUS AND GEOMETRIC, FOR A MAGICAL EFFECT.
PERPENDICULAR LINES AND A PURE GEOMETRIC SHAPE THAT
CUTS THE SPACE FOR A REAL "MAGIC EFFECT". A MODERN
LANTERN TO TAKE WITH YOU AND PLACE WHEREVER YOU WANT.







CAGE

INFORMAZIONI TECNICHE TECHNICAL INFORMATION

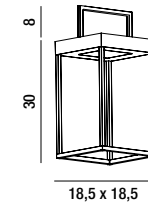

18,5 x 18,5

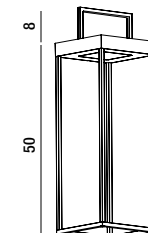

18,5 x 18,5

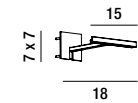

18

Lampada da tavolo ricaricabile a batterie in alluminio verniciato a polvere per uso interno/esterno. Diffusore in acrilico satinato. Doppio Interruttore sulla parte superiore della lampada; uno per l'accensione on/off e la regolazione dell'intensità luminosa, l'altro per attivare il sensore crepuscolare. Rechargeable battery-operated table lamp made of powder-coated aluminum for indoor/outdoor use. Satin acrylic diffuser. Double switch on the top of the lamp; one for switching on/off and adjusting light intensity, the other for activating the twilight sensor.

Durata 9h alla massima potenza
Work time 9h at full power

Ricarica cavo USB 6h o pannello solare 20h (3.7V / 2x4400mAh)
batterie al litio ricaricabili e sostituibili
Recharge USB cable 6h or solar panels 20h (3.7V / 2x4400mAh)
rechargeable and replaceable lithium batteries

LED 2,3W 220LM 2700/3000K



Supporto in metallo per trasformare CAGE in applique a parete.
Metal bracket to transform CAGE into a wall lamp.

COLORI DISPONIBILI AVAILABLE COLOURS

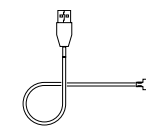

Accessorio incluso: cavo USB per ricarica (carica batterie escluso)
Accessory included: USB charging cable (battery charger excluded)

(91CAV8128)

Ricambi e accessori pag.84-85
Spare parts and accessories p.84-85

LANTERNA

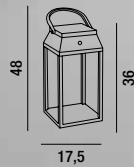

6834 B LC

Lanterna per esterni/interni in alluminio verniciato a polvere colore bianco opaco, interruttore touch
Outdoor/indoor lantern in matt white powder-coated aluminium, touch mode

Durata 9h alla massima potenza
Work time 9h at full power

Ricarica cavo USB 7h o pannello solare 17h (3.7V / 2x2200mAh) batterie al litio ricaricabili e sostituibili
Recharge USB cable 7h or solar panels 17h (3.7V / 2x2200mAh) rechargeable and replaceable lithium batteries

Accessorio incluso: cavo USB per ricarica e carica batterie
Accessory included: USB charging cable and battery charger

(91CAV6834 + 91CARIC6910)
Ricambi e accessori pag.84-85
Spare parts and accessories p.84-85

6833 B

Kit per lanterna 6834 B LC. Gancio a parete colore bianco opaco + cavo con gancio per sospensione
Kit for lantern 6834 B LC. Matt white wall hook + cable with hook for hanging lamp

LED 3W 238LM 3000K

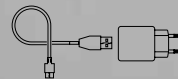



ESTIA

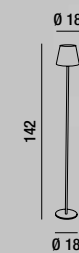

8078 B LC 8078 N LC

bianco opaco
matt white



nero opaco
matt black



Piantana ricaricabile in alluminio con diffusore in acrilico satinato bianco. Interruttore sulla parte inferiore del diffusore, dimmerabile (4 step)
Rechargeable floor lamp with white satin acrylic diffuser switch on the lower part of the diffuser, dimmable (4 step)

Durata 8-16h in base alla regolazione della luminosità
Work time 8-16h according to the brightness adjustment

Ricarica 8h (3.7V / 4000mAh) batterie al litio ricaricabili e sostituibili
Recharge 8h (3.7V / 4000mAh) rechargeable and replaceable lithium batteries

LED \varnothing 2W 240LM 3000K



Accessorio incluso: cavo USB per ricarica e carica batterie
Accessory included: USB charging cable and battery charger

(91CAV8078 + 91CARIC8076)

Ricambi e accessori pag.84-85
Spare parts and accessories p.84-85

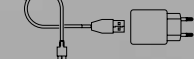

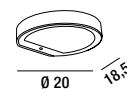

6844 A LC

Applique in alluminio per esterni colore grafite, ricaricabile con pannello solare e sensore crepuscolare
Wall lamp for outdoor use in graphite aluminium, rechargeable with solar panels and twilight sensor

Durata: 3h al 100% di luce e 20h al 15% di luce
Work time: 3h 100% of light and 20h 15% of light

Ricarica 8h (3.7V / 2200mAh)
batterie al litio ricaricabili e sostituibili
Recharge 8h (3.7V / 2200mAh)
rechargeable and replaceable lithium batteries

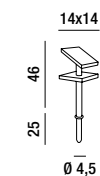
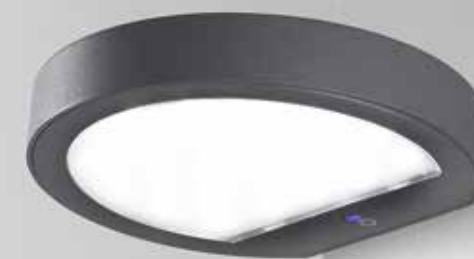
LED \uparrow 2,2W 224LM 3000K

6846 A LC

Palo in alluminio per esterni colore grafite; ricaricabile con pannello solare orientabile e sensore crepuscolare
Pole light for outdoor use in graphite aluminium; rechargeable with adjustable solar panels and twilight sensor

Durata 7h
Work time 7h

Ricarica 8h (3.7V / 2200mAh)
batterie al litio ricaricabili e sostituibili
Recharge 8h (3.7V / 2200mAh)
rechargeable and replaceable lithium batteries

LED \uparrow 1,3W 110LM 3000K

RICAMBI E ACCESSORI
PARTS AND ACCESSORIES

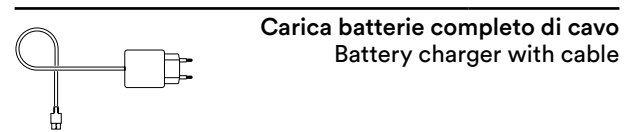

Carica batterie completo di cavo
Battery charger with cable

91CARIC8134
SWAY MOOD

Basetta di ricarica a contatto con cavo USB (carica batterie escluso)
Contact charging base with USB cable (battery charger excluded)

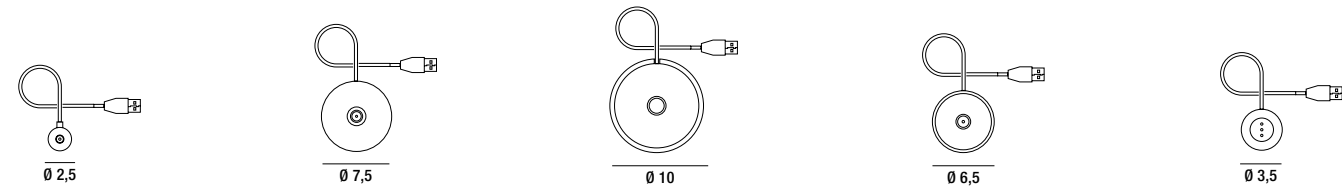

91BAR8112	91BAR8118	91BAR8124	91BAR8125	91BAR8126
PINUP	ELLIOTT	DIVA	MINI DIVA	ETOILE
	MINI ELLIOTT			

Cavo USB per ricarica (carica batterie escluso)
USB charging cable (battery charger excluded)

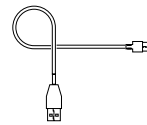

91CAV6834	91CAV6910	91CAV8076 B	91CAV8076 N	91CAV8078	91CAV8114	91CAV8120	91CAV8122	91CAV8128	91CAV8132
		● bianco opaco matt white	● nero opaco matt black						
LANTERNA	MAGNET	KOSMO	KOSMO	ESTIA	KONDA	MANAHATTAN	SOAP	CAGE	ASTRO

Carica batterie (cavo USB escluso)
Battery charger (not including USB cable)



91CARIC6910	91CARIC8076 B	91CARIC8076 N	91CARIC8118	91CARIC8120	91CARIC8124	91CARIC8126	91CARIC8132
	● bianco opaco matt white	● nero opaco matt black					
MAGNET	KOSMO	KOSMO	ELLIOTT	MANAHATTAN	DIVA	ETOILE	ASTRO
LANTERNA	ESTIA		MINI ELLIOTT	SOAP	MINI DIVA	CAGE	
PINUP	KONDA						

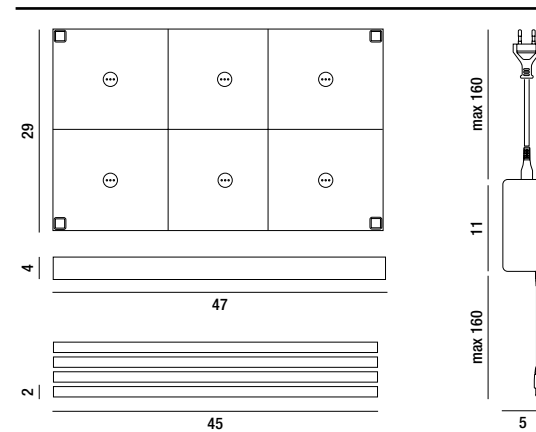

91BAR8126M

Stazione multipla di ricarica (6 postazioni)
Multiple charging station (6 stations)

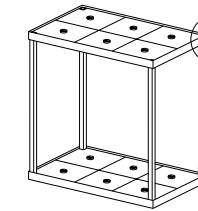

Modulare: permette di collegare in altezza 3 basi
Modular: allows you to connect 3 bases in height

ETOILE

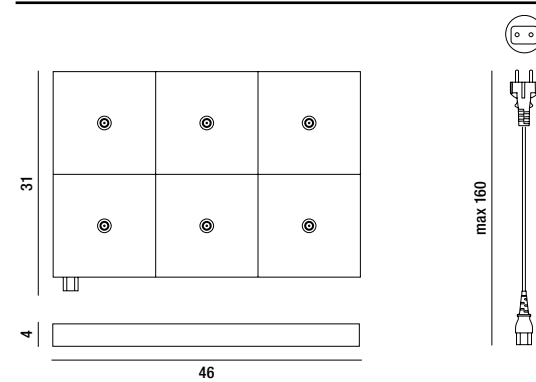
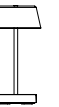

91BAR8124M

Stazione multipla di ricarica (6 postazioni)
Multiple charging station (6 stations)

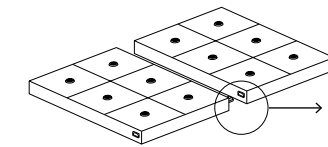

Modulare: permette di collegare in sequenza più basi
Modular: allows you to connect several bases in sequence

DIVA

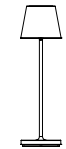

MINI DIVA

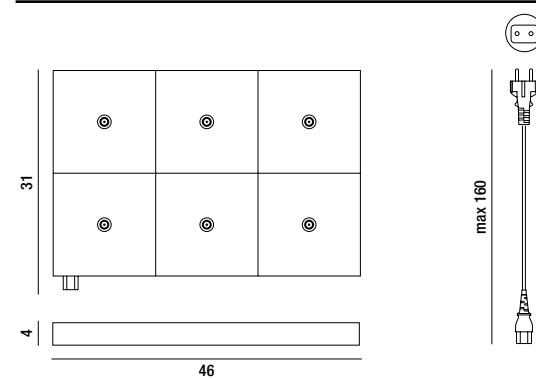

91BAR8118M

Stazione multipla di ricarica (6 postazioni)
Multiple charging station (6 stations)

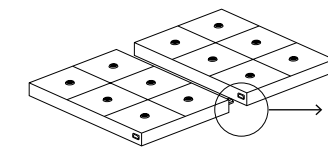

Modulare: permette di collegare in sequenza più basi
Modular: allows you to connect several bases in sequence

ELLIOTT



MINI ELLIOTT

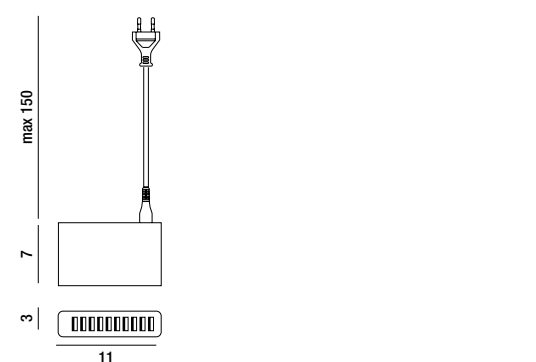

91CARIC.USB-M

Caricatore multipresa USB (universale)
USB multi-socket charger (universal)

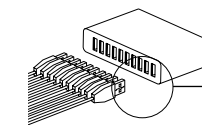

Permette la ricarica di max 10 dispositivi contemporaneamente
Allows the charging of up to 10 devices at the same time

LEGENDA
 KEY

Questa icona indica che il prodotto è dotato di un kit luce con led integrato. This symbol indicates that the product is equipped with a light kit with integrated LED.



Questa icona indica che il prodotto in questione ha la possibilità di variare la colorazione luce. This icon indicates that the product in question has the possibility to vary the light color.



Questa icona indica che il prodotto in questione ha la possibilità di regolare l'intensità della luce. This icon indicates that the product in question has the possibility to adjust the intensity of the light.



Questa icona indica che il prodotto funziona tramite batteria ricaricabile con cavetto USB. This symbol indicates that the product works with a rechargeable battery by USB charging.



Questa icona indica che il prodotto funziona con batteria sfruttando l'energia solare e ricaricandosi tramite pannello solare. This symbol indicates that the product works with battery using solar energy and recharging through the solar panel.



Questa icona indica che il prodotto è in grado di accendersi autonomamente non appena il sole tramonta, e di spegnersi nel momento in cui compare l'alba. This icon indicates that the product is able to turn itself on as soon as the sun sets, and turn off when dawn appears.

INDICE COLLEZIONI
 COLLECTIONS INDEX

ASTRO	54
CAGE	72
DIVA	32
ELLIOTT	20
ESTIA	81
ETOILE	40
KONDA	44
KOSMO	62
LANTERNA	78
MAGNET	64
MANHATTAN	58
MINI DIVA	36
MINI ELLIOTT	24
PINUP	28
SOAP	50
SOLAR	82
SWAY MOOD	2

INDICE DEGLI ARTICOLI
 ITEMS INDEX

6834 B LC	78	8119 SV CT	27	8132 N LC	57
6844 A LC	83	8120 B LC	61	8134 B CT	18
6846 A LC	83	8120 N LC	61	8134 E CT	18
6910 B	71	8120 TO LC	61	8134 GS CT	18
6910 E	71	8122 B LC	53	8136 B CT	18
6910 N	71	8122 GS LC	53	8136 E CT	18
6912 B	71	8122 R LC	53	8136 GS CT	18
6914 B	71	8122 SB LC	53	8138 B CT	18
6916 B	71	8122 SV LC	53	8138 E CT	18
6918 B	71	8124 B LC	35	8138 GS CT	18
8076 B LC	62	8124 E LC	35	8140 B CT	18
8076 N LC	62	8124 GS LC	35	8140 E CT	18
8078 B LC	81	8124 R LC	35	8140 GS CT	18
8078 N LC	81	8124 SB LC	35	8141 B	19
8112 B CT	31	8124 SV LC	35	8141 E	19
8112 E CT	31	8125 B LC	39	8141 GS	19
8112 N CT	31	8125 E LC	39	8142 B	19
8112 SV CT	31	8125 GS LC	39	8142 E	19
8114 B LC	49	8125 R LC	39	8142 GS	19
8114 N LC	49	8125 SB LC	39	8143 B	19
8115 N	49	8125 SV LC	39	8143 E	19
8116 B LC	49	8126 B CT	43	8143 GS	19
8116 N LC	49	8126 N CT	43	8144 B	19
8118 B CT	23	8128 B CT	77	8144 E	19
8118 GS CT	23	8128 GS CT	77	8144 GS	19
8118 SB CT	23	8130 B CT	77	8145 B	19
8118 SV CT	23	8130 GS CT	77	8145 E	19
8119 B CT	27	8131 B	77	8145 GS	19
8119 GS CT	27	8131 GS	77		
8119 SB CT	27	8132 B LC	57		

PERENZ srl
via Feltrina, 4
32038 Quero Vas
Belluno - Italy

office
T. +39 0439 78.70.26 r.a.

showroom
T. +39 0439 78.84.44

F. +39 0439 78.71.25

perenz@perenz.it
www.perenz.it

Materiale pubblicitario non soggetto a cessione. La società Perenz srl si riserva la facoltà di modificare, in qualsiasi momento e senza preavviso, le caratteristiche tecniche dei modelli illustrati nel presente catalogo. I colori si intendono indicativi. Tutti i nostri prodotti sono realizzati secondo le vigenti normative europee e certificati CE. Vietato l'utilizzo e la vendita dei nostri prodotti on-line senza autorizzazione. Vietata la riproduzione totale o parziale del presente catalogo.

The advertising material is the property of Perenz srl. The company reserves the right to change the technical features of the models featured in this catalogue at any time and without any prior notice. The colours are for indication purposes only. All our products are manufactured in conformity with the stringent EU standards and CE certified. It is strictly forbidden to use or sell our products on-line without prior authorisation. To copy any part of this catalogue is strictly forbidden.

©DITRE IDEAS MAKERS

graphic artwork & photo editing
Ditre.com

photo
Quasarfoto.com

content
Marta Zacchigna

location
Bosco del falco agriturismo
Volpago del Montello (TV)
p. 5 - 7 - 10 - 14 - 16 - 26 - 46 e 72

printed in Italy
June 2023



PERENZ.IT